

Fiber Optic Light Sources

Industrial, Machine Vision, Stereo Microscopy

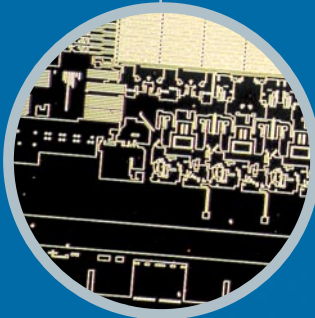

Wafer (Ringlight – incident darkfield)

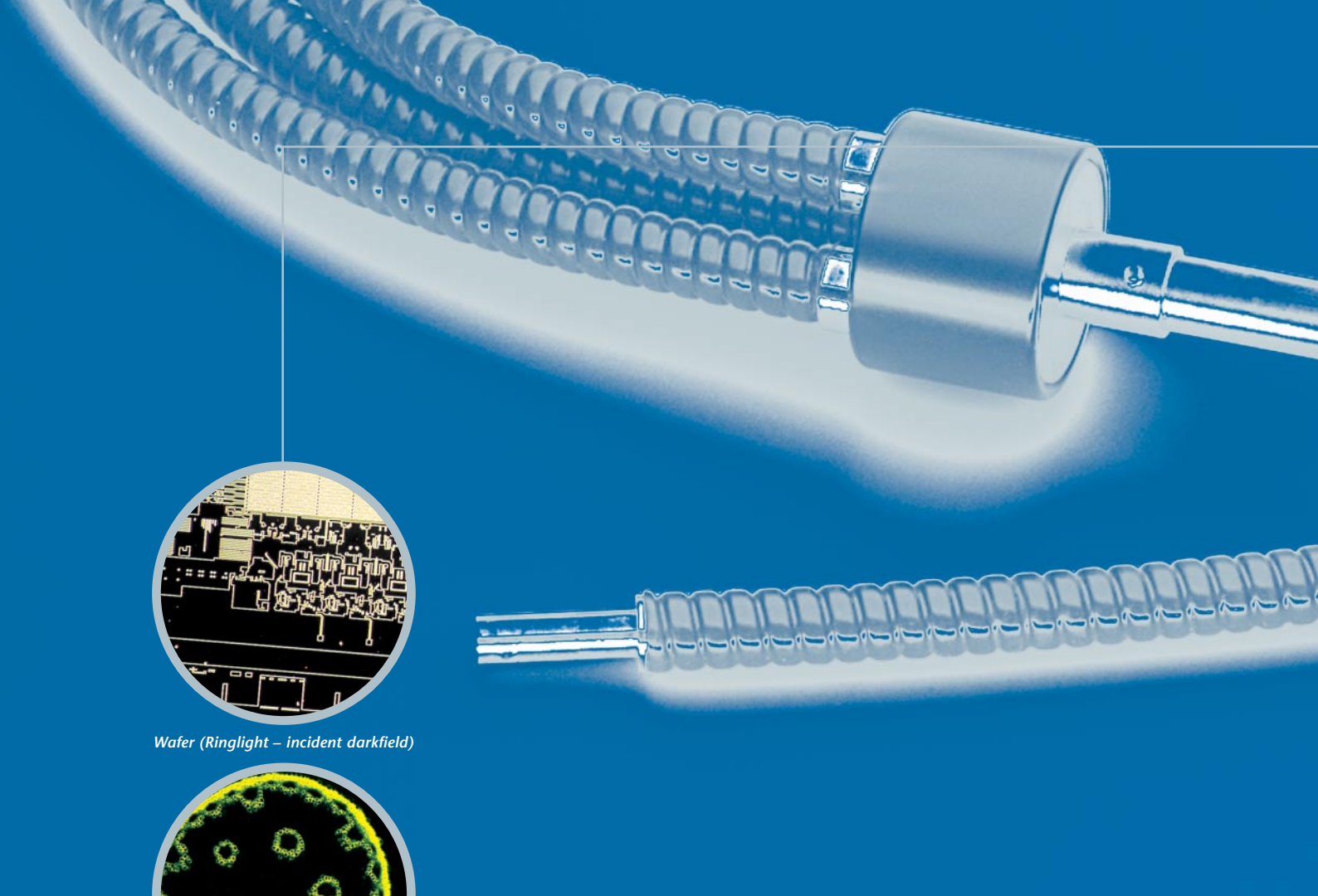
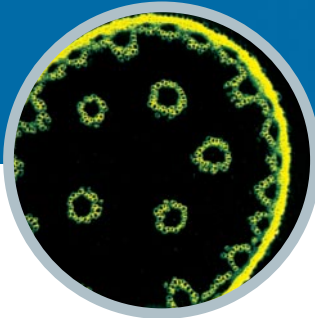

Lily of the valley (Light guide – blue excitation fluorescence)

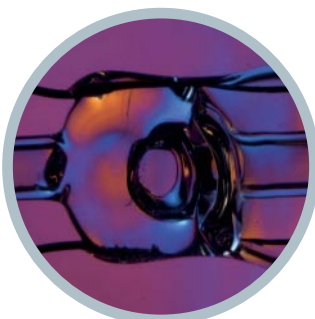

Halogen Bulb (Transmitted light stage with polarizer)

In-depth expertise in Stereo Microscopy, Macroscopy and Machine Vision

SCHOTT, a leader in the manufacture of fiber optic and LED solutions for industrial, machine vision, microscopy and forensic applications, presents an extensive offering of cold light sources. SCHOTT recognizes your demand for light that is more intense, controlled and creatively packaged, all within the confines of remaining cost-effective. SCHOTT's light sources are loaded with special features and specifically optimized to meet your individual requests.

Numerous applications can benefit from regulated light, intense light, cooler light sources and longer lasting bulbs. SCHOTT's light sources are designed using quality materials and components. Long lifetime of the units is achieved by thermal overload protection in combination with quiet high throughput fans for optimized ventilation. Long lifetime of the light bulbs is achieved with the soft start feature of the electronic circuits.

Based on different types of high performance cold light reflector lamps, the design of each optical path has been optimized resulting in efficient coupling of the light into the light guides and excellent uniformity in the illuminated area.

SCHOTT Fiber Optic Light Sources

The image shows several white, braided fiber optic cables against a blue background. One cable in the foreground is shown with its clear glass end, which is emitting a bright blue light. Another cable is visible in the upper left corner, also with its glass end. The cables are arranged in a curved, overlapping pattern, creating a sense of depth and focus on the technology.

This leads to two different product lines with specifically designed light guides for the respective lines: the KL series and the ACE®, DCR®, and MHR® light sources. Mechanical or opto-mechanical adapters are available to interchange between the light sources. Please contact SCHOTT for further details.

Private Labeling Options

SCHOTT offers the option of private labeling cold light sources to provide customers with the freedom to market their products as a complete package. Please contact us for further information and details.

Cold Light through SCHOTT's glass fibers

Cold light sources are devices for intense illumination of objects with infrared-free "cold light". All heat radiation is filtered out by means of specifically optimized heat filters. The remaining visible light is precisely transmitted to the illuminated area using SCHOTT's high transmission glass fiber light guides. SCHOTT has over 30 years of experience in the production and processing of glass fibers. From optical glass manufacturing and individual fiber drawing to final light guide assembly, everything remains in SCHOTT's capable hands. The benefit for you? Stringent demands during glass fiber development and production at SCHOTT guarantee the best in quality and production standards.

In addition to the extensive range of standard light guides, SCHOTT offers excellent expertise and engineering capabilities for custom specific solutions. If you require more detailed information, please contact a SCHOTT facility near you. The main application fields for cold light sources from SCHOTT are Stereo Microscopy, Machine Vision and Macroscopy. However, they are also preferred for applications in medical technology, forensic science and general laboratory use. Last but not least, they are also well established illuminations in professional studio photography and color effect photography.

KL 200

cold, compact and capable



The KL 200 is a versatile, compact and cost effective 20-watt halogen cold light source. Small space requirements combined with excellent light efficiency in an attractive modern design make this unit the right choice for a variety of general lighting applications in the fields of Stereo Microscopy, Macroscopy and Photography.

Simple light adjustment by means of a 3-step light intensity control, easy and safe lamp change, and quick exchange of light guides, allow extremely easy handling of this light source.

Special efforts are taken during the development of optimized convection cooling of the unit, which makes a fan redundant. Consequently, the light source in its injection molded housing is totally free of noise and vibration. This enables the unit to be utilized in varying environments from industry to medical or biological labs, to photo studios or home-tech applications.

The light source is available in 120- and 240-volt versions. A broad range of light guides with active diameters of up to 7 mm (.28") as well as a selection of color filters, polarizers and focussing accessories completes the offering. Please refer to the system diagram on this page and the SCHOTT Standard Product Catalog for details.

The KL 200 LCD has been approved and certified by VDE (230 volt version) and CSA (C/US) (120 volt version). The 230-volt version carries the CE conformity label.

Filter holder with yellow filter

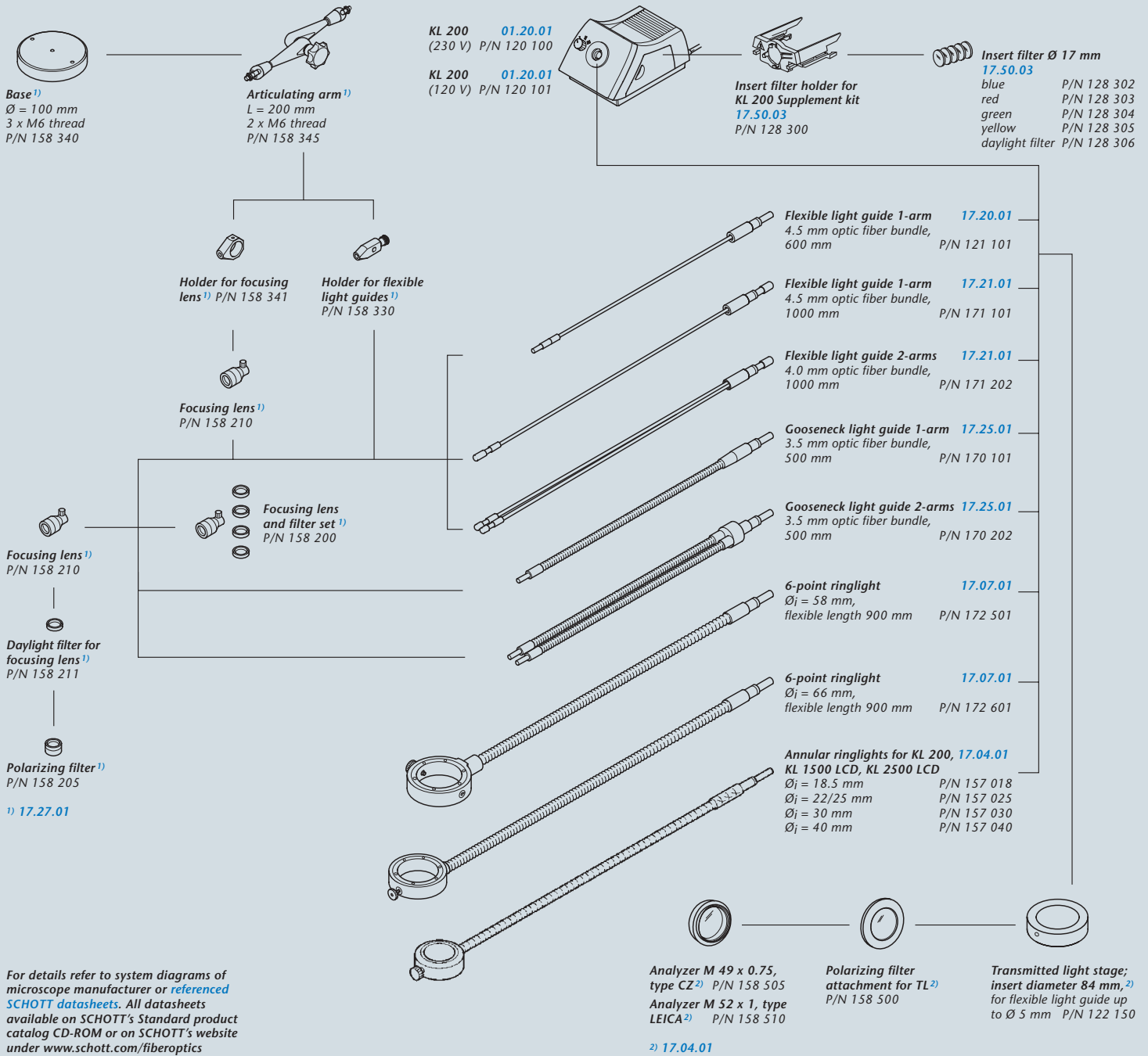

System diagram KL 200



Self clamping light guide socket for active diameters up to 7 mm



Lamp change door for easy lamp and filter exchange



3-step intensity control button

KL 1500 LCD

High Performance, elegantly cased

The KL 1500 LCD is the performance leader in the field of 150-watt halogen cold light sources. With its outstanding modern design combined with optimized, homogeneous light output and variable light control options, this light source has been designed for applications in Stereo-Microscopy and Macroscopy in laboratory, industrial, medical and forensic applications.

The eye-catching Light Control Display indicates the color temperature of a halogen lamp as well as various operational modes. Continuous mechanical dimming enables a constant color temperature, whereas the step-less electronic intensity control allows for the optimization of lifetime of the halogen lamp. For short periods of light enhancement the new turbo position gives 20% more light as the standard setting. A swing-in optics tuned to the EFR-type halogen lamp optimizes light coupling into small diameter light guides. Thus, the light intensity and uniformity at the exit of light guide improves, which enables the use of thinner, more flexible and less expensive light guides. A broad range of light guides with active bundle diameters up to 9 mm (.35") is offered, completed by a selection of color filters and other accessories. Please refer to the system diagram on page 10/11 and the SCHOTT Standard Product Catalog for details.

The stackable injection molded housing is designed to keep direct stray light to a minimum. It offers comfortable and quick lamp change through the lamp compartment door, as well as an easy-to-change filter slide to help contribute to pleasant working conditions. Electronical stabilization of the lamp voltage provides constant light output in case of fluctuations of the AC input voltage. The KL 1500 LCD is available in 120- and 230-volt versions. The KL 1500 LCD has been approved and certified as laboratory and electromedical device by VDE (230 volt version) and CSA (C/US) (120 volt version). The 230 volt version carries the CE conformity label.

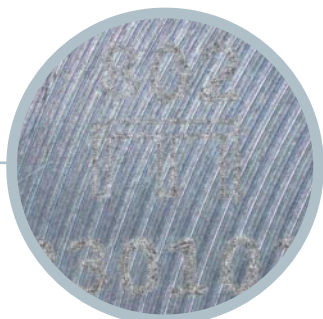

Piston (Ringlight brightfield)



Piston (Ringlight with Polarizer)

Liquid crystal display indicating color temperature and various operating modes.



Two options are available for controlling light intensity:

- A voltage stabilized electronic dimmer which simultaneously adjusts light intensity and color temperature.
- A mechanical dimmer which controls the light intensity at a constant color temperature. The stepless control of the mechanical aperture optimizes uniform object illumination in all positions.



*Stacking capability:
The light sources can
be stacked without
impairing any function
or ease of operation.*



*Optional Flashport
unit*



Options: For photo-documentation purposes in zoology, industry, forensics and studio photography, the KL 1500 LCD and KL 2500 LCD can be optionally upgraded with a **Flashport** unit. The Flashport converts commercially available flash units from the Metz company into an effective flash illumination for Stereo Microscopy use. This significantly reduces exposure time and enables documentation of fast moving or extremely light absorbing specimens.

*Fiber optic socket and
swing-in lens for light
guides with fiber bundle
diameters up to max.
9 mm.*



*Functional lamp com-
partment: The time test-
ed technology ensures
easy lamp replace-
ment without using
any tools.*

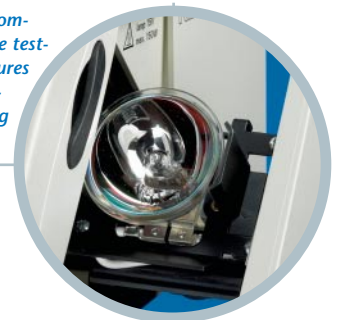

KL 2500 LCD

The Benchmark in Performance

With its new design and unique performance spectrum, the KL 2500 LCD is setting a new benchmark in the field of halogen cold light sources. The premium model KL 2500 LCD offers a decisive advantage over its sister model KL 1500 LCD for light demanding applications: Fitted with a 250-watt cold light reflector lamp, the KL 2500 LCD transmits more than twice the amount of light of the KL 1500 LCD. This unparalleled performance makes the KL 2500 LCD the instrument of choice for the most challenging applications in Stereo Microscopy and Macroscopy as well as in Forensic Science.

Equipped with the same outstanding features as the KL 1500 LCD, the KL 2500 LCD accepts light guides with bundle diameters up to 15 mm (.6"), evenly illuminated with the ELC-type halogen lamp. The larger bundle diameters in combination with the 250-watt lamp power enable demanding applications as GFP fluorescence microscopy or short exposure macro-photography as well as light demanding incident darkfield illuminations. Please refer to the system diagram on page 10/11 and the SCHOTT Standard Product catalog for details.

The KL 2500 LCD is equipped with a 5-position filter wheel, which makes filter selection quick and easy. Color filters and special GFP-fluorescence excitation filters are also available.

In addition, electronic accessories such as remote control or tilt switch can be connected to the analog socket in the front panel, enabling remote light source operation or connection of an RS-232-Interface.

The KL 2500 LCD has been approved and certified as laboratory and electromedical device by VDE (230 volt version) and CSA (C/US) (120 volt version). The 230 volt version carries the CE conformity label.

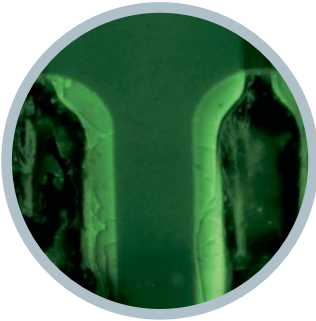

Electronic board (Light guide – blue excitation fluorescence)



Electronic board (Light guide brightfield)

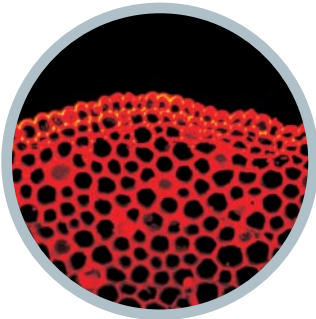

Lily of the valley (Light guide – green excitation fluorescence)



Fingerprint (Light guide – blue excitation fluorescence)

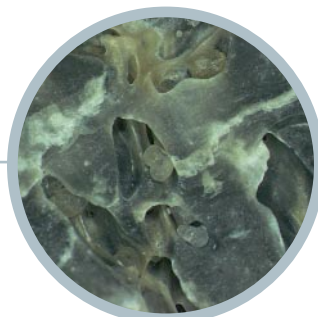

Oyster shell (Ringlight brightfield)

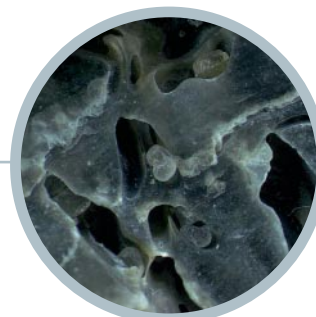

Oyster shell (Ringlight darkfield)



Light guide socket with adapter for active diameters up to 9 mm



Light guide socket without adapter for active diameters larger than 10 mm



Socket for electronic accessories such as remote control, tilt switch and RS 232 interface



Filter wheel with five filter positions: Change of the wavelength range of the light with just a turn of the wheel.



System diagram KL 1500 LCD | KL 2500 LCD

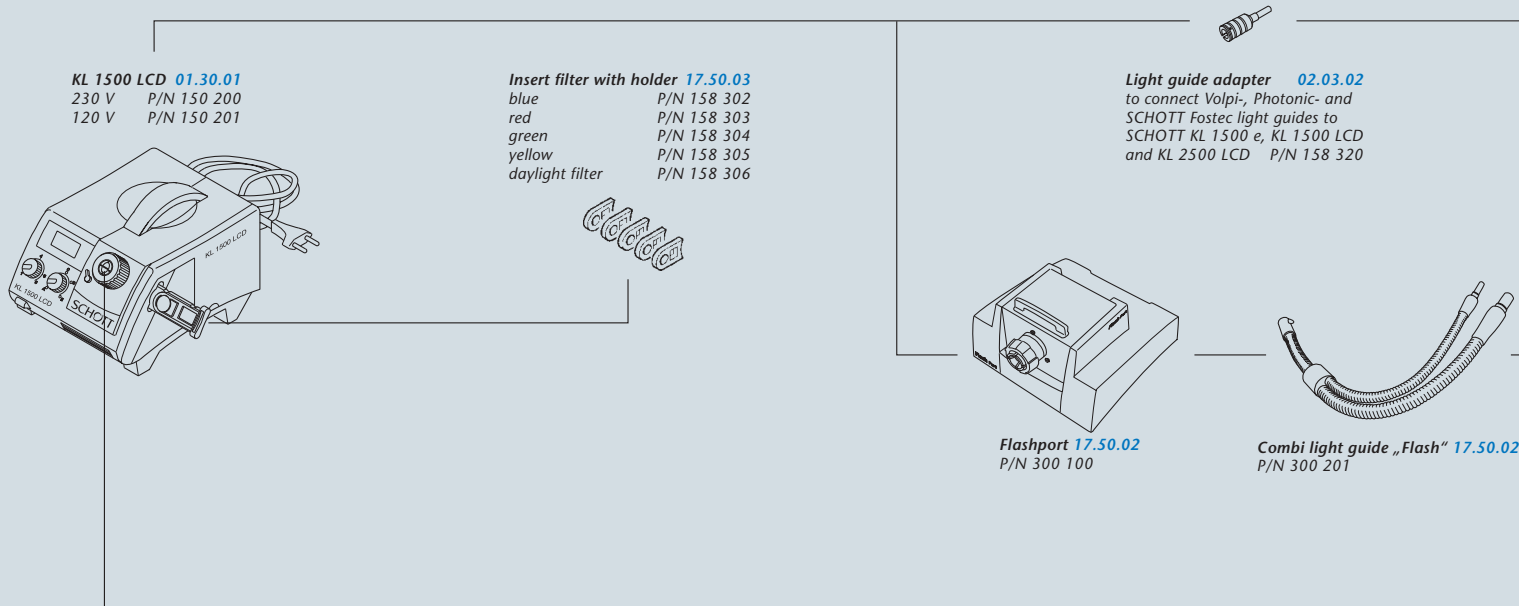

Objective adapter for ringlights onto microscope objectives of major microscope manufacturers available.
For details refer to system diagrams of microscope manufacturer or [referenced SCHOTT datasheets](#).
All datasheets available on SCHOTT's Standard product catalog CD-ROM or on SCHOTT's website under www.schott.com/fiberoptics

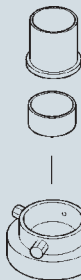

Annular ringlight for incident darkfield 17.05.01
flexible length approx. 1000 mm P/N 157 405

4-point ringlight 17.06.01
flexible length approx. 1000 mm
 $\varnothing_i = 30$ mm P/N 157 401
 $\varnothing_i = 66$ mm P/N 157 402

Mini ringlight 17.04.01
flexible length approx. 1000 mm
M-PVC, with changeable adapter for connecting on KL 200/KL 750 or KL 1500 LCD/KL 2500 LCD
 $\varnothing_i = 18.5$ mm P/N 157 018
 $\varnothing_i = 22.0/25.0$ mm P/N 157 025
 $\varnothing_i = 30.0$ mm P/N 157 030
 $\varnothing_i = 40.0$ mm P/N 157 040

Annular ringlight 17.01.01
flexible length approx. 1000 mm
 $\varnothing_i = 58$ mm P/N 157 410
 $\varnothing_i = 66$ mm P/N 157 420

Maxi ring light 17.03.01
 $\varnothing_i = 150$ mm P/N 157 440

Polarisation filter 17.01.01
for annular ring light $\varnothing_i = 66$ mm P/N 158 430
for annular ring light $\varnothing_i = 58$ mm P/N 158 440

Holder for Maxi ringlight 17.03.01
 $\varnothing_i = 58$ mm P/N 157 445

Lightline with adjustable front lens, 17.30.01
flexible length approx. 1000 mm, M-PVC
Slit 50 x 1.2 mm P/N 160 100
Slit 100 x 0.6 mm P/N 160 110
Slit 200 x 0.3 mm P/N 160 120

Gooseneck light guide 17.25.01
1-branch $\varnothing = 4.5$ mm/600 mm P/N 154 101

Gooseneck light guide 17.25.01
2-branch $\varnothing = 4.5$ mm/600 mm P/N 154 202

Gooseneck light guide 17.25.01
3-branch $\varnothing = 4.5$ mm/600 mm P/N 154 302

Flexible light guide 17.20.01
1-branch, M-PVC P/N 155 101
(only for KL 1500 LCD)
 $\varnothing = 3.0$ mm/1000 mm P/N 155 101
 $\varnothing = 5.0$ mm/1000 mm P/N 155 100
 $\varnothing = 5.0$ mm/1600 mm P/N 155 102
 $\varnothing = 8.0$ mm/1000 mm P/N 155 103

Flexible light guide 17.21.01
2-branch, M-PVC P/N 155 204
 $\varnothing = 4.5$ mm/1000 mm P/N 155 204
 $\varnothing = 5.0$ mm/1600 mm P/N 155 205

Flexible light guide 17.21.01
3-branch, M-PVC P/N 155 206
 $\varnothing = 4.5$ mm/1000 mm P/N 155 206

Lightline with adjustable focusing optics and tilt angle, non-slip 17.30.01
length of flexible bundle 1500 mm
Line 300 x 0.3 mm P/N 160 130

Annular ringlight "Jumbo" 17.02.01
 $\varnothing_i = 66$ mm P/N 257 420

Flexible light guide 17.25.01
M-PVC $\varnothing = 12$ mm/1000 mm P/N 250 101
M-PVC $\varnothing = 15$ mm/1000 mm P/N 250 102
M-PVC $\varnothing = 15$ mm/1500 mm P/N 250 103

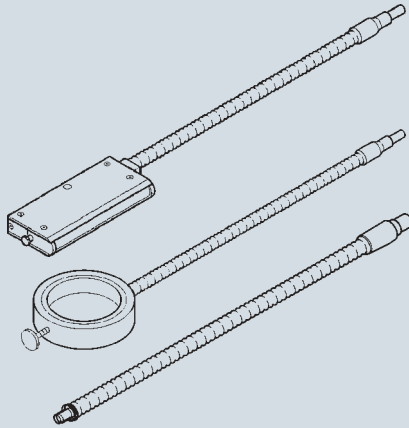

KL 2500 LCD 01.40.01
230 V P/N 250 200
120 V P/N 250 201

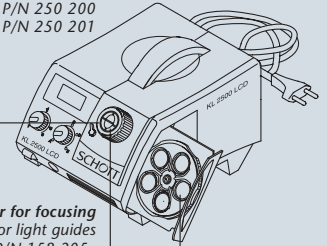

Focusing lens without filter¹⁾ for light guides
 $\varnothing = 12/15$ mm P/N 158 210

Polarization filter for focusing lens¹⁾, twistable for light guides
 $\varnothing = 12/15$ mm P/N 158 205

Electronic accessoires 17.50.01
Y-piece for simultaneous operation of tilt switch (258 403) and remote control (258 402) P/N 258 400
Cable extension P/N 258 401

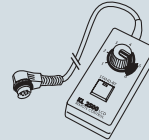

Remote control P/N 258 402



Tilt switch P/N 258 403

Focusing lens and filter set for light guides up to $\varnothing = 5$ mm; blue, red, green, yellow P/N 158 200

Polarisation filter for focusing lens¹⁾
P/N 158 205

Daylight filter for focusing lens¹⁾
P/N 158 211

Focusing lens for light guides¹⁾
up to $\varnothing = 5$ mm P/N 158 210

Holder for focusing lens¹⁾
P/N 158 341

Polarization filter for focusing lens, twistable¹⁾ for light guides
 $\varnothing = 8$ mm P/N 158 206

¹⁾ 17.27.01

Focusing lens without filter¹⁾ for light guides
 $\varnothing = 8$ mm P/N 158 215

Insert filter $\varnothing 28$ mm for fluorescence excitation for filter wheel and filter slider (KL 1500 LCD) 17.50.03
blue $\lambda = 484$ nm P/N 258 313
green $\lambda = 515$ nm P/N 258 314

Insert filter $\varnothing 28$ mm for filter wheel and filter slider (KL 1500 LCD) 17.50.03
blue P/N 258 302
red P/N 258 303
green P/N 258 304
yellow P/N 258 305
daylight filter P/N 258 306

Articulating arm¹⁾ with 2 x M6 connecting threads P/N 158 345

Base for articulating arm¹⁾ with 3 x M6 connecting threads P/N 158 340

Transmitted light stage 17.28.01
 $\varnothing 84$ mm, for flexible light guide up to $\varnothing 5$ mm P/N 122 150

Polarization filter attachment for TL 17.28.01 P/N 158 500

Holder with M6 thread¹⁾ P/N 157 430
for slit ringlight
 $\varnothing_i = 58$ mm, $\varnothing_i = 66$ mm
for 4-point ringlight
 $\varnothing_i = 30$ mm, $\varnothing_i = 66$ mm
for flexible light guide
 $\varnothing = 12$ mm, $\varnothing = 15$ mm

Holder with M6 thread¹⁾ for flexible light guide up to $\varnothing = 5$ mm P/N 158 330
for flexible light guide up to $\varnothing = 8$ mm P/N 158 335

Analyzer M 49 x 0.75 17.28.01 P/N 158 505

Analyzer M 52 x 1 17.28.01 P/N 158 510

ACE[®] Light Source

Rugged and Reliable



Iris diaphragm for stepless intensity control 0–100% while maintaining color temperature



Mechanical shutter module for altering light transmittance

The ACE® is a cost effective and reliable 150-watt cold light source which provides premium quality, intense light for Stereo Microscopy, Macroscopy and Machine Vision applications. The rugged and compact design in a stackable metal frame enables operation in harsher industrial environments as well as laboratory use.

The modular concept of the Modulamp® assembly allows flexible adaptation depending on the users requirements. The basic version is equipped with an electronic (solid state) dimmer for continuous setting of light intensity and optimized lamp life. The Modulamp® assembly offers the choice of three halogen lamp types (EKE, EJA and DDL) with different focus diameters, intensities, color temperatures and lifetimes.

The ACE® Remote Light Source has all of the features of the premium quality ACE® Light Source with the added convenience of a remote control. The positive locking, quick-disconnect, shielded cable connects to a control that provides variable light intensity and on/off features.

Optional on all ACE® versions, the Modulamp® assembly is available with an infinite setting, 13-blade iris diaphragm to control the intensity while keeping the color temperature constant. In addition, the light sources can be upgraded with an optional shutter unit.

The ACE® Light Source will fully illuminate active bundle diameters up to 16 mm (.63"). A broad range of fiber optic light guides and accessories are offered as well. Please refer to the system diagram on page 18/19 and the SCHOTT Standard Product Catalog for details.

The ACE® Light Source is offered in both 115- and 230-volt versions with a detachable IEC cord.

The ACE® Light Source is approved and certified by CSA and NRTL/C to U. L. specifications and carries the CE conformity label.



Grasshopper (Ringlight brightfield)



Grasshopper (Ringlight with polarized light)



ACE® Remote Light Source for remote control of intensity and on/off



Electronic component
(Ringlight brightfield)



Electronic component (Ringlight
brightfield with polarized light)

DCR[®] III

Maximum DC Performance



Lamp change indicator
shows when halogen bulb
needs replacement

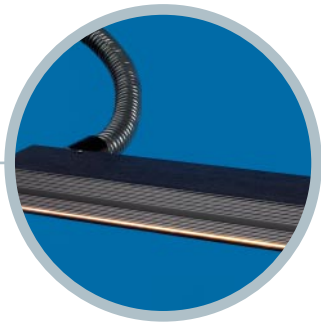

Fiber optic lightline for intense, uniform line illumination



Fiber optic backlight for bright, even transmissive illumination



Optional: DCR®III Remote Light Source Kit for remote operation of lamp head from power supply

The DCR® III is a DC-regulated 150 watt-halogen light source which provides intense, cold illumination for Machine Vision applications. Powered by an internal switching power supply with universal input voltage, the light output does not flicker with the 50 Hz AC-frequency. This makes the DCR® III the light source of choice for various Machine Vision applications.

Equipped with similar, established features of the ACE® Light Source, the DCR® III consists of rugged and stackable housing, Modulamp® assembly with the choice of three lamp types, 9-pin analog connector as well as optional Iris-diaphragm, Shutter and RS-232-connection.

The DCR® III Light Source has additional unique features:

- Electronic current limiting protects the unit from overheating due to defective and aging lamps.
- A lamp change indicator at the front panel of the unit alerts the user of impending lamp failure due to an open or partly shorted filament. This information is also available via the analog 9-PIN connector.
- Transient protection allows for remote location of the lamp, which enables the use of the DCR® III Remote Light Source Kit.
- The electronically stabilized internal switching power supply accepts universal input voltage from 90–265 VAC. Thus, the light output does not change when the input voltage fluctuates.

The DCR® III Light Source will fully illuminate active bundle diameters up to 16 mm (.63”). A broad range of fiber optic light guides and accessories is being offered. Please refer to the system diagram on page 18/19 and the SCHOTT Standard Product Catalog for details.

The **DCR® III Remote Light Source Kit** allows remote operation of the lamp head for energy chain and robot applications, utilizing all of the DC-regulated performance of the DCR® III in a remote package.

The Modulamp® assembly of the DCR® III is used with this kit to allow the light head to operate in potentially harmful environments while the power supply remains at a safe distance. The Kit includes a 10’ (3 m) shielded extension chord for use in dynamic applications where a fiber bundle may fail in time. The lightweight design is perfect for robotic arm applications.

The DCR® III Light Source is approved and certified by CSA to U. L. specifications and is CE compliant for 2001 initiatives.



MHR-50[®] Light Source

Impressive and Innovative

The MHR-50[®] Light Source is a compact and powerful Metal Halide cold light source for applications which require highly intense, white light such as Machine Vision and Microscopy. The 50-watt metal-halide lamp combines longevity (3500 h), excellent focusing efficiency (due to a short arc length), and extremely high uniformity of the light spot. The exceptional performance of the MHR-50[®] lamp generates significantly more light output than halogen lamps with similar lifetimes.

Electronic dimming features of the MHR-50[®], between 40 and 60 watts, is complemented with an infinite setting, 13-blade iris diaphragm of the Modulamp[®] assembly. This enables mechanical dimming of the light intensity between 0 and 100 % while keeping the color temperature constant.

The MHR-50[®] Light Source will fully illuminate active bundle diameters up to 12.7 mm (.5"). All standard light guides from the system diagram on page 18/19 will fit this light source. Please refer to the SCHOTT Standard Product Catalog for details.

Based on the metal frame design of the ACE[®] and DCR[®] Series Light Sources, the MHR-50[®] offers the same basic features such as rugged and stackable housing, Modulamp[®] assembly with a 50-watt Metal Halide lamp, 9-pin analog connector, shutter and RS-232-connection. The light source accepts universal input voltage of 90-265 VAC and has a detachable IEC chord.

The MHR-50[®] Light Source is approved and certified by CSA to U. L. specifications and is CE compliant for 2001 initiatives.



Equalizer™ Light Feedback Module for stabilized light output



Display of stabilized light output



Universal Light Source for applications with 24 VDC access

Equalizer™ Light Feedback Module – Advanced and Adaptable

The Equalizer™ Light Feedback Module advances the DCR® III and MHR-50® Light Sources to an unparalleled illumination system with highly stabilized light output for the most demanding Machine Vision applications. The light remains constant over operation regardless of lamp degradation or change.

Two configurations are available depending on the application requirements. The Equalizer™ can be used with a reference Modulamp® unit and any standard fiber optics. Maximum stabilization of $\pm 1\%$ is achieved using custom fiber optic products with integrated reference bundles.

Exclusive features consist of a user defined intensity setting to provide maximum control of the light output and lamp life. The Equalizer™ Light Feedback Module has easy-to-use front panel knobs for calibrating, intensity control, and fixed light output control. LED's located on the front panel indicate the stabilized lamp intensity. The system is designed for a single calibration; the original set light levels are maintained, even after replacement of the halogen lamps.

The Equalizer™ Light Feedback Module is compatible with all DCR® III Series and MHR-50® halogen light sources and can be stacked onto the units for space saving requirements. A lamp change indicator alerts the user of impending lamp failure due to an open or partly shorted filament.

Universal Light Source – Unique and Economical

In OEM applications, where DC power is already available and the need for an economical light source exists, the Universal Light Source is the first choice. The compact and lightweight design makes it excellent for use in mobile applications or on robotic arms. The Universal Light Source allows for operation of multiple halogen lamps in the MR-16 format, and includes the Modulamp® assembly and connectors.

A broad range of Standard fiber optic light guides and accessories can be used with the Universal Light Source. Please refer to the system diagram on page 18/19 and the SCHOTT Standard Product Catalog for details.



Iris diaphragm for stepless intensity control 0–100% while maintaining color temperature



Electronic stepless power control 80–120%

System diagram ACE[®], MHR[®], DCR[®] III

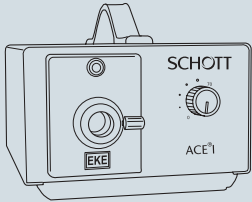

ACE[®] Light Source A20500
01.01.01
 Cost effective light source with maximum lamp life. Excellent for standard microscopy.

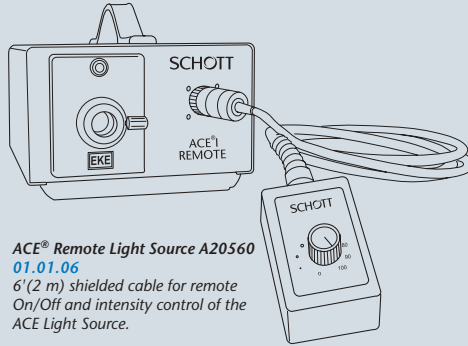

ACE[®] Remote Light Source A20560
01.01.06
 6' (2 m) shielded cable for remote On/Off and intensity control of the ACE Light Source.

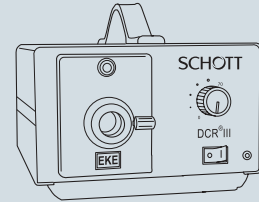

DCR[®] III Light Source A20800
01.10.01
 DC regulated, full featured light source for intense, cool illumination. Excellent for all microscopy & machine vision applications.

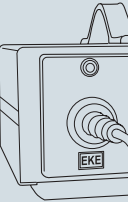

- Universal Ringlights [04.01.01](#)
- Midi and Mini Ringlights [04.02.01](#)
- Ringlights – 60 mm [04.03.01](#)
- Ringlights – 58 mm [04.04.01](#)
- Large Ringlights [04.05.01](#)
- Darkfield Ringlights [04.10.01](#)
- 4 Pt. Darkfield Illuminator [04.15.01](#)

- Ringlight Adapters [04.20.01](#)
- Ringlight Polarizers and Analyzers [04.20.02](#)
- Ringlight Reflector Rings [04.20.03](#)

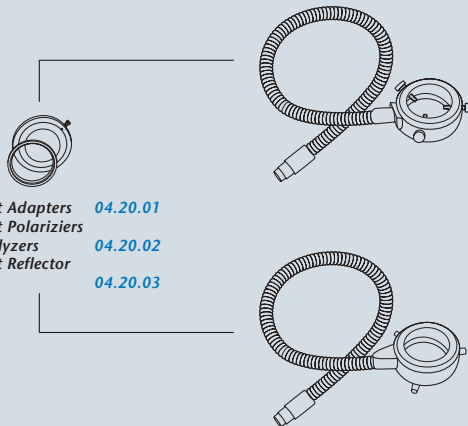

- Single and Dual Backlights [08.01.01](#)
- PANELite[®] Backlights [08.05.01](#)

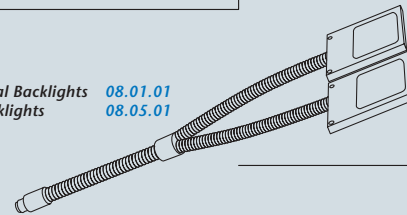

- 1", 2", 3" Lightlines [07.01.01](#)
- Lightlines [07.02.01](#)
- Spatially Randomized Lightlines [07.03.01](#)
- 45° Lightline [07.04.01](#)

- Lightline Lenses [07.20.01](#)
- Lightline Linear Polarizer Kits [07.20.02](#)

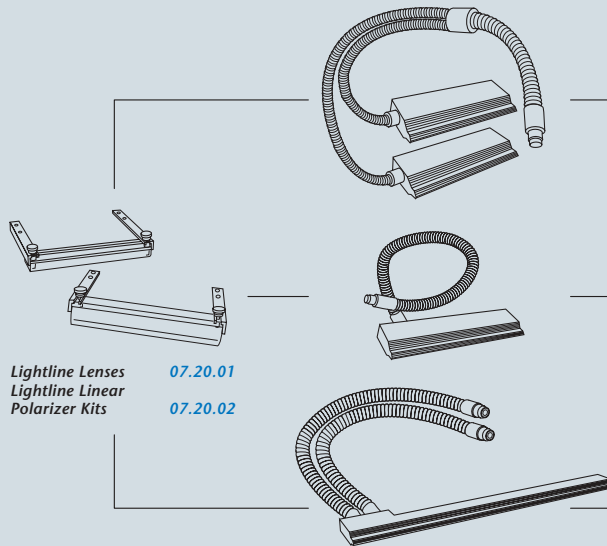

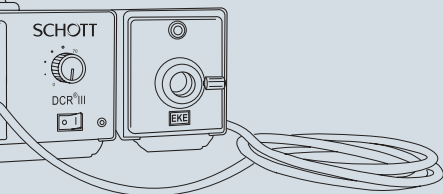

DCR[®] III Remote Light Source Kit A20850 [02.07.01](#)
 Allows remote operation of DCR III[®] lamp head for energy chain and robot arm applications in machine vision

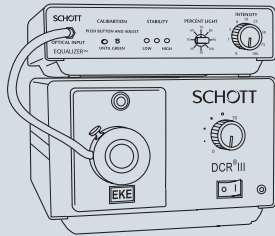

Equalizer[™] Light Feedback Module A20801 [02.06.01](#)
 Provides in combination with the DCR III stabilized light output over time. Designed for the most demanding machine vision applications.

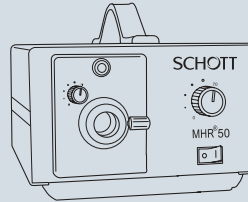

MHR[®]-50 Light Source A20900 [01.10.02](#)
 Regulated metal halide light source for intense, white light with high color temperature. Excellent for demanding microscopy and machine vision applications.



Universal Light Source A20855 [02.07.01](#)
 Cost effective solution for applications where DC power is already available in Machine Vision.

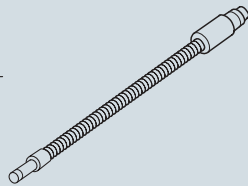

Single Bundles [05.01.01](#)
Dual and Quad Bundles [05.02.01](#)
Randomized and Calibrated Bundles [05.05.01](#)

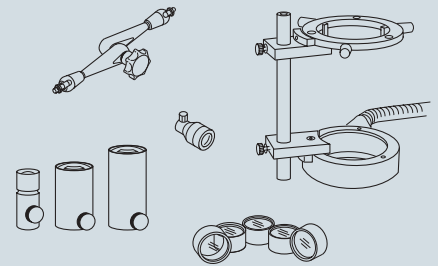
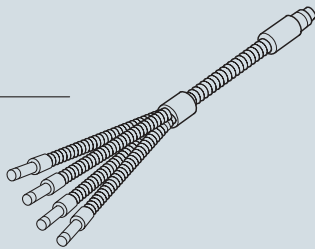

Filters, Diffusers, Spot Lenses [15.01.01](#)
Bundle Extenders [15.05.01](#)

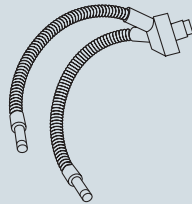

Single and Dual Goosenecks [06.01.01](#)
Combination Goosenecks/Bundles [05.05.01](#)

Support Apparatus [16.01.01](#)
Ringlight Support Apparatus [16.01.01](#)
Gooseneck/Bundle Support App. [16.03.01](#)
Lightlines Support App. [16.04.01](#)

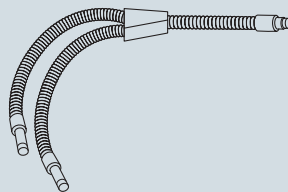

For further details check the [referenced datasheets](#) on SCHOTT's Standard Product Catalog CD-ROM or on SCHOTT's website under www.schott.com/fiberoptics

Fiber Optics

SCHOTT North America, Inc.

62 Columbus Street

Auburn, NY 13021-3137

USA

Phone: +1 315/255 2791

Fax: +1 315/255 2695

E-mail: schott-fostec@us.schott.com

www.us.schott.com/fiberoptics

10146 e 1003 5.0 ba/wo Printed in Germany

SCHOTT
glass made of ideas